

UCC T3 PLUS and UCC S3 CMM controller installation guide

<http://www.renishaw.com>

General information

© 2014 Renishaw plc. All rights reserved.

This document may not be copied or reproduced in whole or in part, or transferred to any other media or language, by any means, without the prior written permission of Renishaw.

The publication of material within this document does not imply freedom from the patent rights of Renishaw plc.

Disclaimer

RENISHAW HAS MADE CONSIDERABLE EFFORTS TO ENSURE THE CONTENT OF THIS DOCUMENT IS CORRECT AT THE DATE OF PUBLICATION BUT MAKES NO WARRANTIES OR REPRESENTATIONS REGARDING THE CONTENT. RENISHAW EXCLUDES LIABILITY, HOWSOEVER ARISING, FOR ANY INACCURACIES IN THIS DOCUMENT.

Trademarks

RENISHAW® and the probe emblem used in the **RENISHAW** logo are registered trademarks of Renishaw plc in the UK and other countries.

apply innovation is a trademark of Renishaw plc.

All brand names and product names used in this document are trade names, service marks, trademarks, or registered trademarks of their respective owners.

Windows XP, Windows 2000, Vista and Windows 7 are registered trade names of the Microsoft Corporation.

All trademarks and trade names are acknowledged.

WEEE



The use of this symbol on Renishaw products and/or accompanying documentation indicates that the product should not be mixed with the general household waste upon disposal. It is the responsibility of the end user to dispose of this product at a designated collection point for waste electrical and electronic equipment (WEEE) to enable reuse or recycling. Correct disposal of this product will help save valuable resources and prevent potential negative effects on the environment. For more information, please contact your local waste disposal service or Renishaw distributor.

Warranty

Renishaw plc warrants its equipment for a limited period (as set out in our Standard Terms and Conditions of Sale) provided that it is installed exactly as defined in associated Renishaw documentation.

Prior consent must be obtained from Renishaw if non-Renishaw equipment (e.g. interfaces and/or cabling) is to be used or substituted. Failure to comply with this will invalidate the Renishaw warranty.

Claims under warranty must be made from authorised service centres only, which may be advised by the supplier or distributor.

UCC T3 PLUS and UCC S3 CMM controller installation guide

<http://www.renishaw.com>

Care of equipment

Renishaw probes and associated systems are precision tools used for obtaining precise measurements and must therefore be treated with care.

Changes to Renishaw products

Renishaw reserves the right to improve, change or modify its hardware or software without incurring any obligations to make changes to Renishaw equipment previously sold.

UCC T3 PLUS and UCC S3 CMM controller installation guide

<http://www.renishaw.com>

EC declaration of conformity

Renishaw plc hereby declares that the UCC T3 PLUS / UCC S3 is in compliance with the essential requirements and other relevant provisions of Directives 2004/108/EC. Contact Renishaw plc if a copy is required.

UCC T3 PLUS and UCC S3 CMM controller installation guide

<http://www.renishaw.com>

FCC (USA only)

Information to user (47CFR section 15.105)

This equipment has been tested and found to comply with the limits for a Class A digital device, pursuant to Part 15 of the FCC rules. These limits are designed to provide reasonable protection against harmful interference when the equipment is operated in a commercial environment. This equipment generates, uses, and can radiate radio frequency energy and, if not installed and used in accordance with the instruction manual, may cause harmful interference to radio communications. Operation of this equipment in a residential area is likely to cause harmful interference, in which case you will be required to correct the interference at your own expense.

Information to user (47CFR section 15.21)

The user is cautioned that any changes or modifications not expressly approved by Renishaw plc or an authorised representative could void the user's authority to operate the equipment.

Equipment label (47CFR section 15.19)

This device complies with part 15 of the FCC Rules. Operation is subject to the following two conditions:

1. This device may not cause harmful interference.
2. This device must accept any interference received, including interference that may cause undesired operation.

UCC T3 PLUS and UCC S3 CMM controller installation guide

<http://www.renishaw.com>

Safety

If the equipment is used in a manner not specified by the manufacturer, the protection provided by the equipment may be impaired.

There are no user serviceable parts inside the equipment.

The UCC T3 PLUS or UCC S3 controller is only warranted and approved for use with the provided PSU - Cincon TRG70A240-02E02.

PSU electrical ratings	
Supply voltage	100 V to 240 Vac \pm 10%
Frequency range	50 Hz to 60 Hz
Power consumption	3 A
Output voltage	24 Vdc
Transient voltages	Installation category II

The UCC T3 PLUS or UCC S3 is isolated from the ac power by disconnection of the IEC mains connector from the supplied PSU. If any additional means of isolation is required, it must be specified and fitted by the machine manufacturer or installer of the product. The isolator / disconnection device must be sited within easy reach of the operator and comply with any applicable national wiring regulations for the country of installation.

The UCC T3 PLUS or UCC S3 is provided with an equipotential bonding point which must be used to connect it to the rest of the installation's grounded structures.

⚠ WARNING: Switching off or isolating the UCC T3 PLUS or UCC S3 may NOT prevent unexpected machine movement. The user is advised to isolate the machine from the electricity supply, compressed air or other energy sources and ensure the machine is at rest and in accordance with the machine manufacturer's instructions before entering the danger zone or performing any maintenance operations.

UCC T3 PLUS and UCC S3 CMM controller installation guide

<http://www.renishaw.com>

Environmental conditions

Indoor use	IP30* (BS EN60529:1992)
Altitude	Up to 2000 m
Operating temperature	+5 °C to +50 °C
Storage temperature	-25 °C to +70 °C
Relative humidity	80% maximum (non-condensing) for temperatures up to +31 °C Linear decrease to 50% at +50 °C
Transient voltages	Installation category II
Pollution degree	2

i * **NOTE:** It may be necessary to house UCC T3 PLUS / UCC S3 in a suitable enclosure according to the installation's environmental conditions to obtain a higher IP rating.

UCC T3 PLUS and UCC S3 CMM controller installation guide

<http://www.renishaw.com>

References and associated documents

It is recommended that the following documentation is referenced when installing the UCC T3 PLUS or UCC S3:

Renishaw documents

Installation and user's guide: PH10 PLUS	H-1000-7592
Installation guide: SPA3	H-1000-7566
Installation and user's guide: MCU	H-1000-5182
UCCassist-2 help	Found within UCCassist-2
User's guide: TP200 and SCR200 probe system	H-1000-5014
Installation guide: PI 200-3	H-1000-7542
Installation, integration and user's guide: SP25M	H-1000-5104
Installation guide: PICS	H-1000-5000
User's guide: AM1	H-1000-4010
Data sheet: AM2	H-1000-2051
Installation and integration guide: SP600, SCR600 and AC1, AC2	H-1000-5175

External documents

National and international standards including the following may be applicable to the finished machine or installation: -

EN 292-2:1991 (Safety of machinery - Basic concepts, general principles for design - Part 2: Technical principles and specifications).

EN (IEC) 60204-1:1997 (Safety of machinery - Electrical equipment of machines - Part 1: General requirements).

UCC T3 PLUS and UCC S3 CMM controller installation guide

<http://www.renishaw.com>

Introduction

The UCC T3 PLUS / UCC S3 are the latest addition to the Renishaw CMM controller product range. They support the complete range of Renishaw two wire touch-trigger probes along with the high performance SP25M and SP600 (UCC S3 only) . Support for conventional contact, strain-gauge sensors (TP200), motorised probe heads, stylus changers and temperature compensation are all built into these controllers.



Key	Description
1	Machine motors
2	Machine scales and readheads
3	Probe head - manual or CNC (PH10 PLUS) - connects to the UCC T3 PLUS / UCC S3 via the machine cabling
4	UCCassist-2 commissioning software and application software
5	UCC T3 PLUS / UCC S3 and power amplifier SPA3 - these connect to the machine cabling
6	MCU joystick - MCUlite-2, MCU5 or MCU W - connects to SPA3
7	PC - connects to UCC T3 PLUS / UCC S3 via an Ethernet cable
8	MCR20 rack

The UCC T3 PLUS / UCC S3 is a controller in a 19 inch rack-mountable enclosure. It is coupled to the CMM host computer by an Ethernet link and to the CMM via external cable interface connectors.

UCC T3 PLUS and UCC S3 CMM controller installation guide

<http://www.renishaw.com>

The UCC T3 PLUS / UCC S3 controllers in conjunction with the SPA3 have the capability of:

- controlling three axes of a CMM (accepting digital readhead signals and generating three axes of motor drive signals)
- accepting input signals from emergency stop, air pressure, crash detector, digital SPA, amplifier faults and all axis inner and outer travel limit switches
- accepting two uncommitted general purpose input signals and generating one uncommitted general purpose output signal
- PH10 and PH10 PLUS interfacing
- directly supporting the TP1, TP2, TP6, TP20 and TP200 touch-trigger probes and SP25 and SP600 scanning probes (UCC S3 only)
- directly supporting the Renishaw TEC (16 channels) and RS232 (Mitutoyo) TEC systems
- providing a +24 V supply for use by the CMM switches
- The UCC T3 PLUS / UCC S3 supports the MCULite-2, MCU5 and MCU W joysticks through the SPA3.

This guide gives information on physical installation, system connections and communications, as well as assistance in fault finding during the installation of the UCC T3 PLUS or UCC S3.

⚠ WARNING: UCC T3 PLUS / UCC S3 are not compatible with PH9, PHS, PH20 and REVO systems. No attempt should be made to connect these system components to the UCC T3 PLUS or UCC S3 as this will result in damage to the product or attached equipment.

Please use this guide in conjunction with the PH10, TP200 and SP25M user's guide in order to fully understand the system's features, capabilities and operation.

The UCC T3 PLUS / UCC S3 **do not** support TP7.

Front panels

UCC T3 PLUS

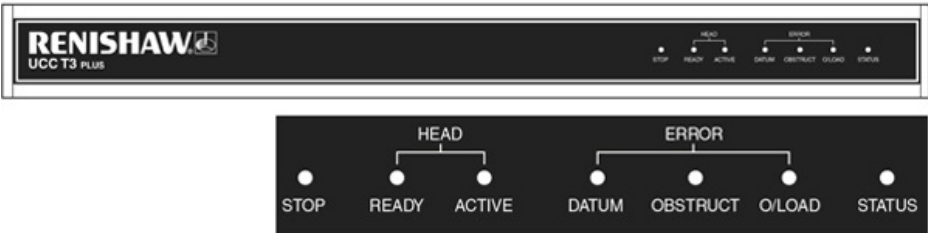

UCC S3

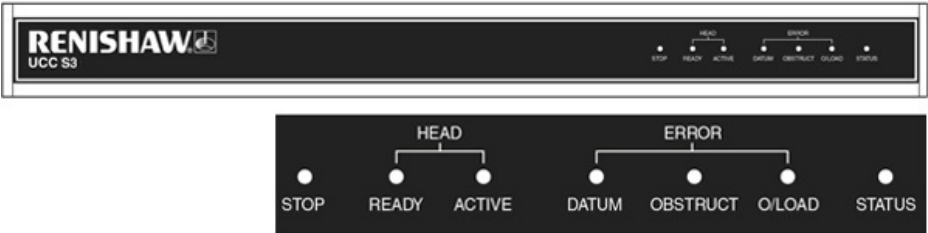

UCC T3 PLUS and UCC S3 CMM controller installation guide

<http://www.renishaw.com>

Rear panel layout

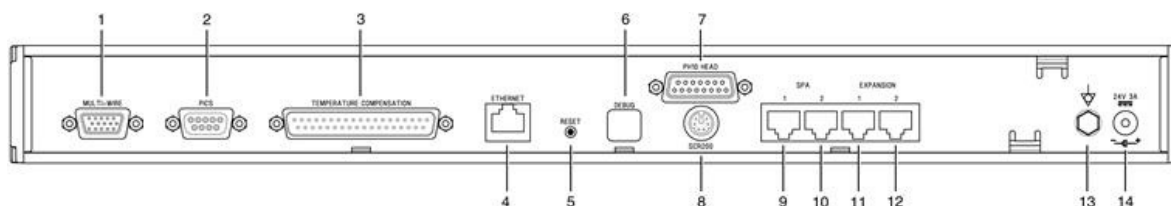

Key	Description	Connector polarity
1	Multiwire connection	SOCKET
2	PICS	SOCKET
3	Temperature compensation connector	PLUG
4	Ethernet communications connector to CMM computer	SOCKET
5	Reset button / IP configure button	
6	Reserved - do not connect	
7	PH10 head connector	SOCKET
8	SCR200 rack input (TP200)	SOCKET
9	RJ45 connector to SPA3	SOCKET
10	RJ45 connector to second SPA3 (not implemented at this time)	SOCKET
11	Reserved	
12	Reserved	
13	Equipotential bond point	BOLT
14	DC power jack 24 V	SOCKET

UCC T3 PLUS and UCC S3 CMM controller installation guide

<http://www.renishaw.com>

Connecting the UCC T3 PLUS or UCC S3 to the host PC

Hardware connection

The host PC must have a dedicated Ethernet connection to the CMM controller. It is recommended that this is not a USB plug-in adapter because of the reduction in speed these devices can produce.

If the host PC is connected to a network, it is necessary to install additional hardware to allow a dedicated connection for UCC T3 PLUS or UCC S3 communication. For details on how to install additional hardware on the host PC, please refer to the manufacturer user's guide.

The CMM controller is capable of using 1 Gbps Ethernet (with appropriate cable).

A 5 m Ethernet cable is provided for this link as part of the CMM controller kit. The cable included is a Cat 5E, cross-over type. Other lengths may be used, but the maximum length is determined by the generic specification for Ethernet connections.

It is recommended that a shielded Ethernet cable is used if there is a likelihood of EMC disruption due to the environment or location of the routed cable.

It is recommended that the cross-over cable is labelled to avoid being mistaken for a non cross-over cable.

Software installation

UCCsuite 4.7 or newer software must be installed on the host PC prior to connection of the UCC T3 PLUS or UCC S3. The UCC software suite can be downloaded from the [Renishaw website](#). After the software has been installed, run UCCassist-2 to set up and configure the CMM controller.

UCC T3 PLUS and UCC S3 CMM controller installation guide

<http://www.renishaw.com>

IP configure / reset button

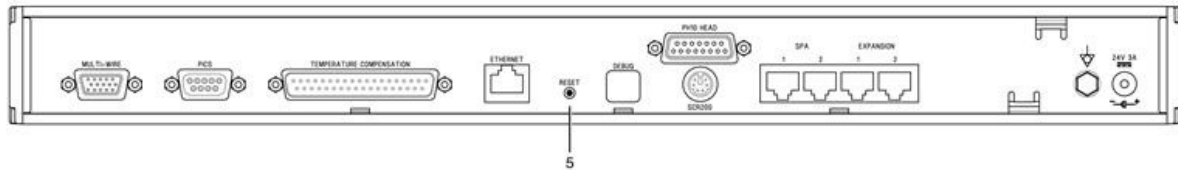

Number 5 on the rear panel is the reset button which has two different functions. The function depends on the operational state of the controller.

1. Pressing and releasing the reset button within fifteen seconds of switching on or rebooting the unit will force the controller into IP configuration state.
2. Pressing and releasing the reset button after the download or whilst operating will cause the unit to restart.

To enter IP configuration state when the unit is already powered, press and release the reset button twice.

UCC T3 PLUS and UCC S3 CMM controller installation guide

<http://www.renishaw.com>

Installation and connection details

Dimensions

Width: 440 mm (17.3 in)

Depth: 180 mm (7.1 in)

Height: 44 mm (1.7 in)

Weight: 2.1 kg (4 lb 10 oz)

UCC T3 PLUS or UCC S3 (CMM controller) can either be free standing or used in a 19 inch rack system.

CAUTION: Ensure the controller is disconnected from the power supply during installation.

Stand-alone installation

The CMM controller unit draws air from the right hand side when viewed from the front and expels air out of the left hand side. A minimum clearance gap of 10 mm is necessary between the sides of the unit and any potential obstruction.

Mounting in a 19 inch rack

The rack mounting kit (Renishaw part number A-5518-0005) contains two brackets and four M5 × 6 mm screws. Assemble the brackets to the CMM controller as shown below:

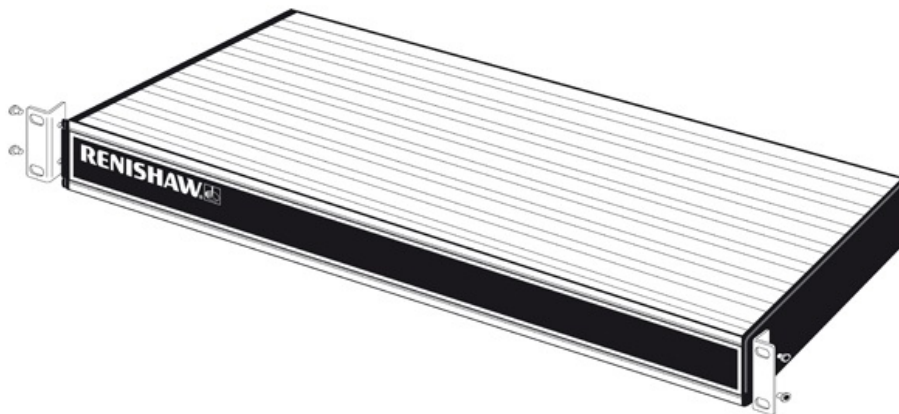

UCC T3 PLUS and UCC S3 CMM controller installation guide

<http://www.renishaw.com>

Earth connection diagram

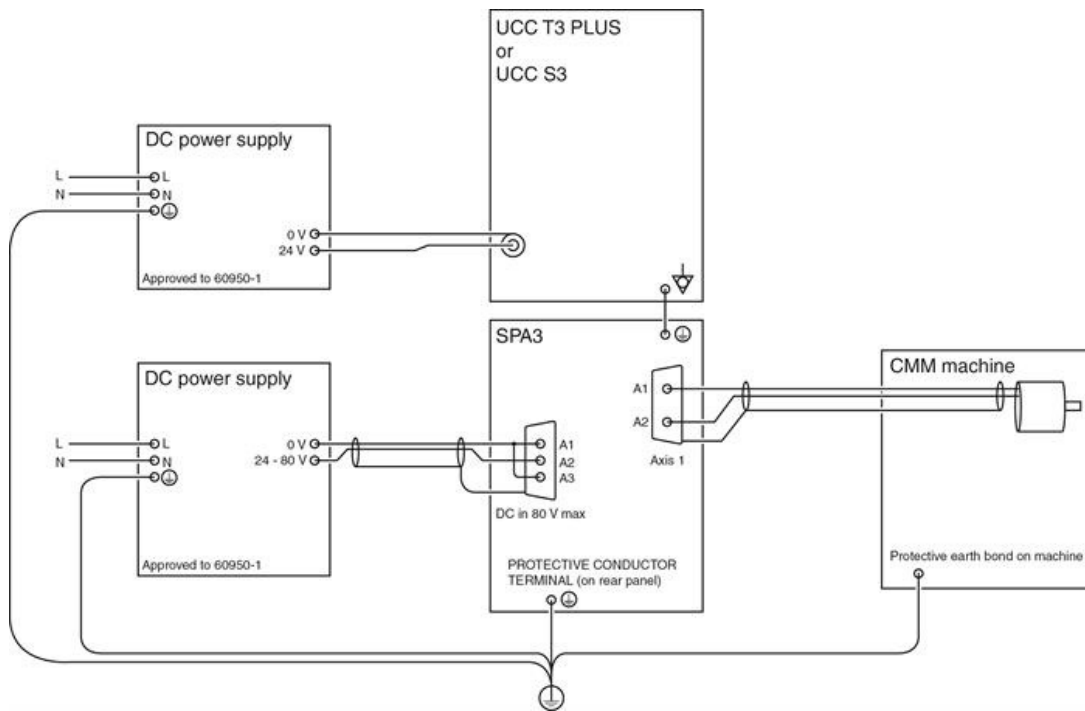

PH10 head connector (15 way D-type socket)

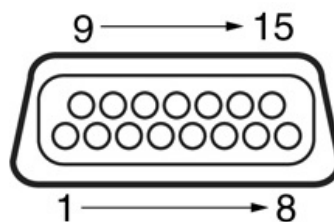

NOTE: For maximum immunity from electrical noise, Renishaw recommends that:

1. Mating shells connectors must be metal bodied.
2. The overall cable screen is continuous and connected to the system ground on the user's equipment through the bodies of the connectors.

CAUTION: For correct system function, the maximum overall single core resistance between the head and the controller **MUST** be less than 2.5 ohm.

UCC T3 PLUS and UCC S3 CMM controller installation guide

<http://www.renishaw.com>

Machine cable:

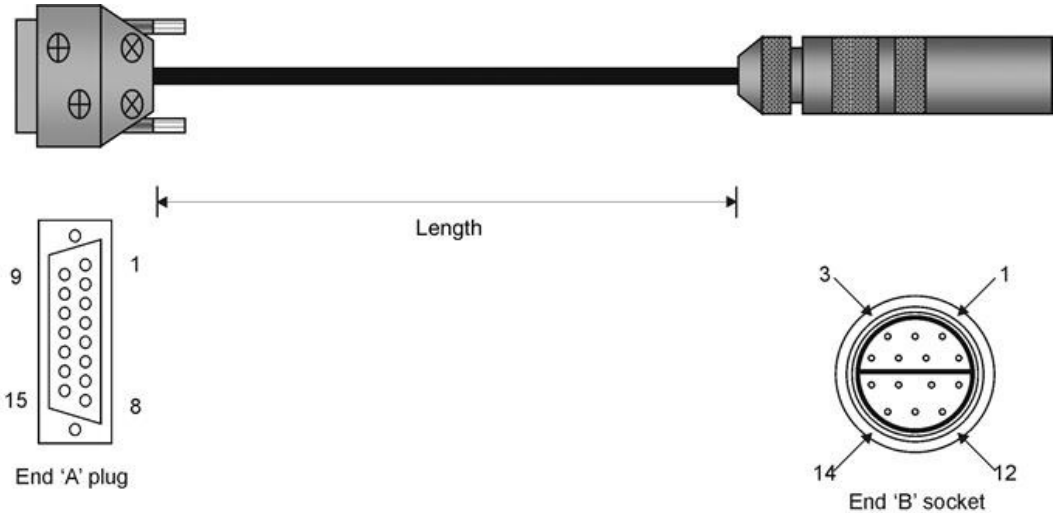

Probe head cable:

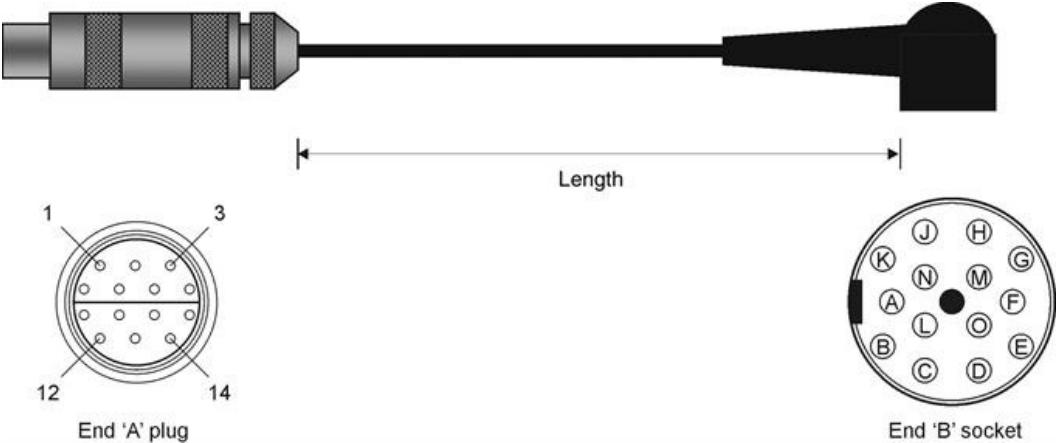

UCC T3 PLUS and UCC S3 CMM controller installation guide

<http://www.renishaw.com>

Signal name	Controller	Controller	Controller	Head	Head	Maximum
	15-way male D-type	Cable PLM 6 - 9	14-way LEMO	12-core	14-way	Current
B-axis feedback	14	Black	(F) 1 (M)	Yellow	E	n/a
Ground sense / head present	1	Brown	(F) 2 (M)	Red	D	n/a
DC reference 12 V	6	Violet	(F) 3 (M)	Brown	C	n/a
0 V	4	Green / red	(F) 4 (M)	Grey	M	1000 mA
Locking motor 8 Vdc nominal	10	Green	(F) 5 (M)	White	H	350 mA
A-axis motor 12 Vdc nominal	12	Red	(F) 6 (M)	Green	L	350 mA
Not connected	2	Turquoise	(F) 7 (M)	Not connected	-	-
A-axis motor 12 Vdc nominal	11	White	(F) 8 (M)	Dark blue	F	350 mA
B-axis motor / probe contact	7	Pink	(F) 9 (M)	Violet	A	350 mA
B-axis motor / probe contact	15	Orange	(F) 10 (M)	Black	B	350 mA
Screen	Body	Screen	(F) 11 (M)	Screen	N, O	-
A-axis feedback	3	Yellow	(F) 12 (M)	Orange	G	n/a
LED and datum	8	Blue	(F) 13 (M)	Turquoise	J	15 mA
Motor / probe switch	5	Grey	(F) 14 (M)	Pink	K	40 mA

NOTE: The male pins numbered 4 and 7 of the 14 way LEMO connector are linked together.

Renishaw head cables

Cable	Name	Part number	Length	Type	Connector	Connects to	Connector	Connects to
Head cable	PL5	A-1016-7672	0.4 m to 0.8 m	Coiled	PH10 type	PH10 head	14-pin LEMO plug	Machine cable
Head cable	PL6	A-1016-7673	0.8 m to 1.6 m	Coiled	PH10 type	PH10 head	14-pin LEMO plug	Machine cable
Head cable	PL12	A-1016-7674	0.1 m	Straight	PH10 type	PH10 head	14-pin LEMO plug	Machine cable
Head cable	PL13	A-1016-7675	0.1 m to 0.2 m	Coiled	PH10 type	PH10 head	14-pin LEMO plug	Machine cable
Machine cable	PLM6	A-1016-7564	6 m	Straight	15-pin D-plug	UCC T3 PLUS / UCC S3	14-pin LEMO socket chassis mount	Head cable
Machine cable	PLM7	A-1016-7563	4 m	Straight	15-pin D-plug	UCC T3 PLUS / UCC S3	14-pin LEMO socket chassis mount	Head cable
Machine cable	PLM8	A-1016-7677	6 m	Straight	15-pin D-plug	UCC T3 PLUS / UCC S3	14-pin LEMO socket	Head cable
Machine cable	PLM9	A-1016-7678	4 m	Straight	15-pin D-plug	UCC T3 PLUS / UCC S3	14-pin LEMO socket	Head cable

UCC T3 PLUS and UCC S3 CMM controller installation guide

<http://www.renishaw.com>

Temperature compensation connector (37 way D-type plug)

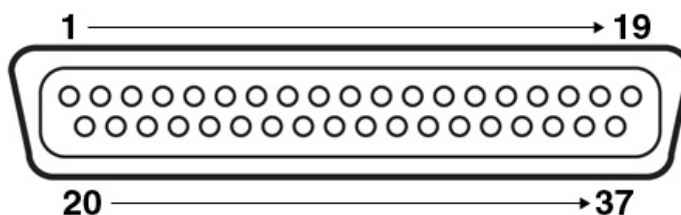

Pin number	Description	Pin number	Description
1	Channel 1 input	20	Channel 1 return
2	Channel 2 input	21	Channel 2 return
3	Channel 3 input	22	Channel 3 return
4	Channel 4 input	23	Channel 4 return
5	Channel 5 input	24	Channel 5 return
6	Channel 6 input	25	Channel 6 return
7	Channel 7 input	26	Channel 7 return
8	Channel 8 input	27	Channel 8 return
9	Channel 9 input	28	Channel 9 return
10	Channel 10 input	29	Channel 10 return
11	Channel 11 input	30	Channel 11 return
12	Channel 12 input	31	Channel 12 return
13	Channel 13 input	32	Channel 13 return
14	Channel 14 input	33	Channel 14 return
15	Channel 15 input	34	Channel 15 return
16	Channel 16 input	35	Channel 16 return
17	Reserved	36	Reserved
18	Reserved	37	Reserved
19	Reserved	Shell	Screen

The thermistors for each channel connect between the CH input and CH return pins. The return signals are NOT zero volts and MUST NOT be connected to any zero volt signal, GND or screen. Do not connect the return signals to anything else apart from the thermistor !

NOTE: For more information regarding the set up and usage of axis and work piece sensors, please read the temperature compensation page of this installation guide.

PICS interface configuration

Configuration of the PICS (product interconnection system) is via UCCassist-2.

UCC T3 PLUS and UCC S3 CMM controller installation guide

<http://www.renishaw.com>

PICS

Renishaw's PICS allows a standard method of connection for real-time signals used by current Renishaw products.

Please refer to the PICS installation guide (Renishaw part number H-1000-5000) for further information when interfaces are fitted.

NOTE: TP7 is not supported with this product.

Stylus change rack (SCR) connector

The SCR200 stylus change rack is connected to the controller via a 6 pin miniature DIN socket. The pin numbers are illustrated and their functions are shown in the table.

SCR200 connector (view on rear panel)

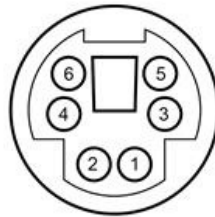

Pin number	Description	Pin number	Description
1	Reset	4	+5 V
2	Fault	5	0 V
3	Inhibit	6	Reserved
Shell	Screen		

Cable lengths

UCC T3 PLUS / UCC S3 to SPA3 connection

The units must be linked by the supplied shielded CAT 5E 300 mm cable(s), no other cables are to be used.

Ethernet cable link to PC

This is a standard Ethernet CAT 5E cable, a 5 m cable is supplied as part of the CMM controller kit. Lengths up to 100 metres can be used.

UCC T3 PLUS and UCC S3 CMM controller installation guide

<http://www.renishaw.com>

System interconnection diagrams

PH10 PLUS system with standard two wired touch-trigger probes

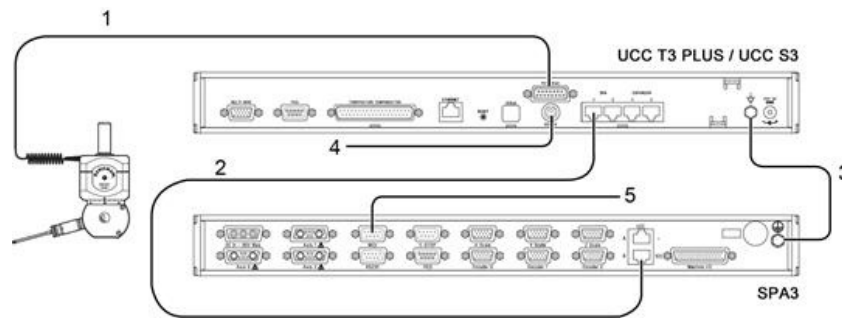

Key	Description	Key	Description
1	Head cable(s)	4	SCR200 rack connection
2	RJ45 cable (supplied)	5	MCU connection
3	16 / 0.2 mm earth connection		

PH10 PLUS system with multiwire scanning probes

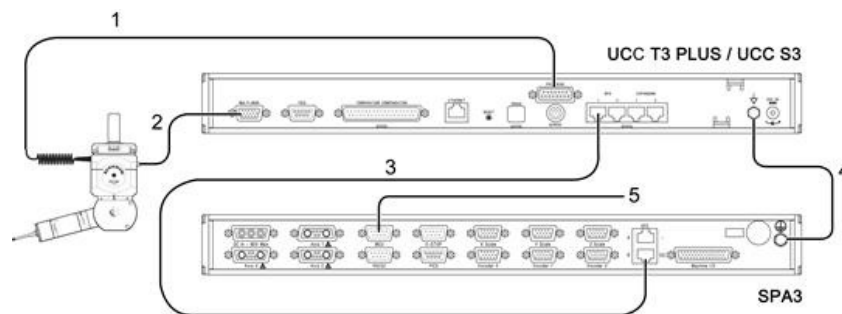

Key	Description	Key	Description
1	Head cable(s)	4	16 / 0.2 mm earth connection
2	Multiwire cable	5	MCU connection
3	RJ45 cable (supplied)		

UCC T3 PLUS and UCC S3 CMM controller installation guide

<http://www.renishaw.com>

Temperature compensation

i NOTE: Thermal compensation is activated and setup through UCCassist-2.

For installation and setup details refer to the TEC installation guide (Renishaw part number H-1000-5105).

UCC T3 PLUS and UCC S3 CMM controller installation guide

<http://www.renishaw.com>

Troubleshooting

Front panel LEDs

UCC T3 PLUS or UCC S3 visual diagnostics



Key to LED colour and behaviour:

LED	Description
	LED on
	LED flashing off / on
	LED flashing red / green
	LED off
	LED flashing red / blue

Name	LED colour	Function
STOP		PHC10-3 PLUS asserting PICS STOP when lit
STOP		PI 200 asserting PICS STOP
HEAD READY		Head ready for use when lit
HEAD ACTIVE		Head indexing when lit
DATUM ERROR		Head datum error when lit
OBSTRUCT ERROR		Head obstruct error when lit
O/LOAD ERROR		Head overload error when lit

UCC T3 PLUS and UCC S3 CMM controller installation guide

<http://www.renishaw.com>

Name	LED colour	Function
STATUS	○	No LED - no power to UCC T3 PLUS / UCC S3 or downloadable unable to start, power cycle and try again
STATUS	●	Continuous LED - problem with comms link - reboot UCC T3 PLUS or UCC S3 and configure IP
STATUS	⦿	Slow flash - waiting for download
STATUS	●	Continuous light - download successful
STATUS	⦿	Fast flash (5 Hz) - IP configuration mode
STATUS	⦿ ⦿	Dual flash - controller booting
STATUS	⦿ ⦿ ⦿	Internal timeout - reboot UCC T3 PLUS or UCC S3
STATUS	⦿	Fast flash (5 Hz) - communications error - reboot required
STATUS	⦿	Slow flash - scale error - reboot required
STATUS	⦿	Slow flash - problem with download - reboot required (check file type eg UCC2)
STATUS	●	Continuous LED - UCC T3 PLUS or UCC S3 overheated
STATUS	⦿	Slow flash - unit does not have controller ID - return to Renishaw
STATUS	⦿	Fast flash (5 Hz) - no controller ID in IP configuration mode - return to Renishaw

NOTE: A scale error will cause the UCC T3 PLUS or UCC S3 to enter an error state which is not recoverable within a metrology application environment. If a scale error occurs it will be necessary to reinitialise the installation due to the possibility of lost scale counts and metrology being effected.

This section on troubleshooting is a guide to problems associated with the installation and integration of the PH10 system only. Refer to the 'PH10 PLUS installation and user's guide' (Renishaw part number H-1000-5070) regarding problems associated with normal operation of the PH10 system.

The UCC T3 PLUS or UCC S3 will assert PICS STOP under the following conditions:

Condition	Notes
Overload error	Head has been overloaded when locked, causing it to unlock.
Obstruct error	Head has been obstructed when moving to requested position or is unable to lock into it.
Head disconnect	Head removed, cables disconnected, cable break
Datum error	The head has failed to lock up correctly.

Pressing and releasing the E-STOP button will clear the PICS STOP providing the cause has been addressed.

Use the tables below to identify problems you are experiencing with your PH10 PLUS system. If you experience problems which you are not able to identify or solve satisfactorily, please contact Renishaw for further advice.

No head movement in automatic mode:

Possible cause	Solution
Cable / connection fault	Check connection and integrity of cabling between head and controller.

UCC T3 PLUS and UCC S3 CMM controller installation guide

<http://www.renishaw.com>

No probe signal from PH10 PLUS:

Possible cause	Solution
Cable / connection fault	Check connection and integrity of cabling between head and controller.
Multiwire bypass connector not fitted	Fit a multiwire bypass connector which will permit a standard touch-trigger probe signal to reach controller.
Multiwired probe in use (SP25M)	Check that the multiwire cable is correctly fitted to the head. Check that the trigger output to the CMM controller is connected to the multiwired probe interface.

Poor measurement performance associated with the PH10 PLUS:

Possible cause	Solution
Loose mounting of head	Ensure all mounting screws are tight and mounting to CMM is secure.
Probe damping enabled during measurement	Ensure probe damping is not enabled during measurement moves.
Stylus is too close to the surface before taking point	Increase standoff distance in program.

UCC T3 PLUS and UCC S3 CMM controller installation guide

<http://www.renishaw.com>

Maintenance

⚠ WARNING: Maintenance should only be carried out after the machine has been isolated from the electrical supply, compressed air supply or other energy sources in accordance with the machine manufacturer's instructions.

Periodically check that all mounting screws and electrical connectors are securely tightened. Electrical safety checks should include inspecting the mains cable for damage and the safety of the connections. Periodical safety checks should also include the function of the emergency stop system, including operation of all switches integrated into the system.

Remove dust from the external surfaces with a clean dry cloth as the unit is not sealed against liquid.

Filter replacement

UCC T3 PLUS or UCC S3 uses an internal air flow for cooling purposes. This system has a replaceable filter to minimise the ingress of dust. The condition of the of the filter should be checked on a regular basis. It is recommended that this filter is removed and checked/replaced as necessary or every 12 months.

The following procedure should be followed when replacing the air filter:

- Remove power from the controller
- Remove the 19 inch rack mounting brackets (if fitted) by removing the two fixing screws (not shown)
- Pull the head of both the filter retaining clips away from the unit so they disengage
- Pull away the external filter cover
- Remove the filter material from the filter recess
- Replace the filter using the reverse of the method given above (the replacement filter part number is A-5518-0011)



Advisory

It is recommended that periodical metrology tests are performed in order to identify any faults in subsystems eg air bearings, structure, cables, software etc.

Renishaw plc
New Mills, Wotton-under-Edge,
Gloucestershire, GL12 8JR
United Kingdom

T +44 (0)1453 524524
F +44 (0)1453 524901
www.renishaw.com/cmmsupport

RENISHAW 
apply innovation™

**For worldwide contact details,
please visit our main website at
www.renishaw.com/contact**